



Sovitron Interior Pvt.Ltd.



Model Name	SILAS-WL4 Wall Light/ DL-OMT-15302-20
Description	Wall light (Direct-Indirect)

Technical description	Image
-----------------------	-------

Dimension	Dia=150mm H=150mm
Frame	Aluminium Die-cast
Color Tempertaure	4000K
Power	2x10W
Total Luminous Flux	1600 lm
Efficacy	80 lm/W
IP rating	65
Beam angle	12/24/36/60 Degree
Color Rendering	≥80
Mounting	Surface
Optics	Glass Lens
Dimming	NON-Dimmable
Operating Voltage	220-240 VAC
Standard Lifetime	L70 minimum at 50,000 burning hours



Dimension diagram

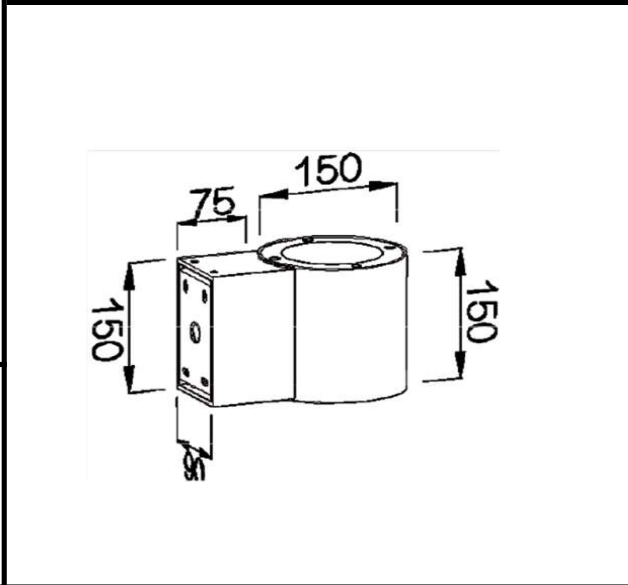

Remarks:-

Address: Plot #7 Saroorpur-Nangla Industrial Area, Ballabgarh-Sohna Road, Faridabad-121005
Email: info@sovitron.com